

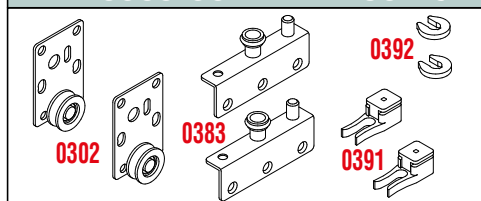

## KIT 0383-302 - MAX 50 KG



### Legenda KIT / Kit Legend

<b>0302</b>	Carrello inferiore senza eccentrico di regolazione <i>Lower truck without adjusting eccentric</i>
<b>0383</b>	Guida superiore DX-SX <i>Right-left upper runner</i>
<b>0391</b>	Fermo superiore <i>Upper stopper</i>
<b>0392</b>	Antisganciamento per guida Art.0383 <i>Clasp for runner Art.0383</i>

### Legenda altri componenti Legend other items

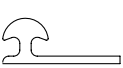
<b>0390</b>		Profilo alluminio superiore <i>Upper aluminium profile</i>
<b>0380</b>		Profilo alluminio inferiore <i>Lower aluminium profile</i>
<b>0300</b>		Profilo alluminio inferiore <i>Lower aluminium profile</i>

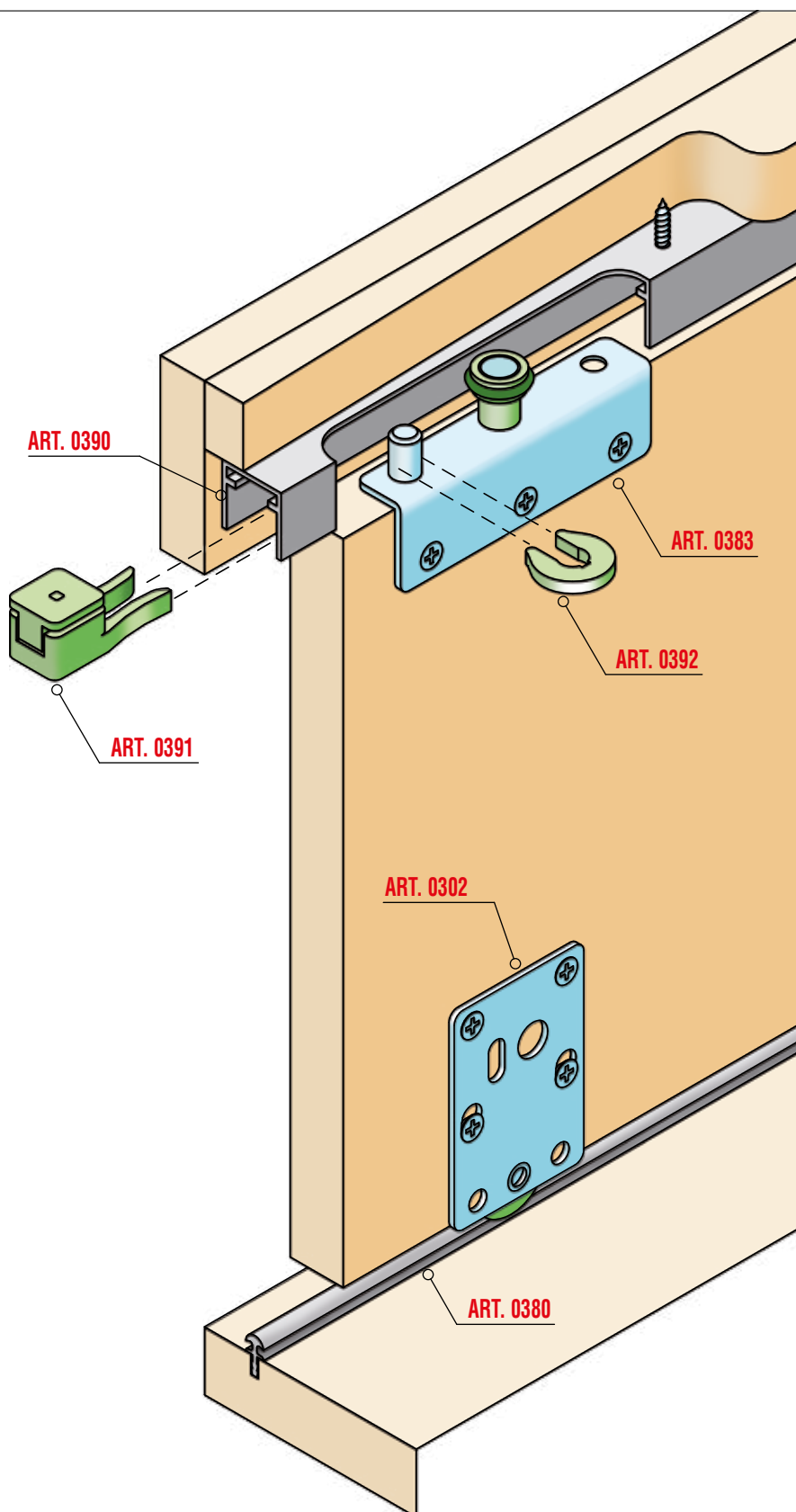



Sistemi scorrevoli per mobili / Sliding systems for furniture

### Sezione verticale / Vertical section

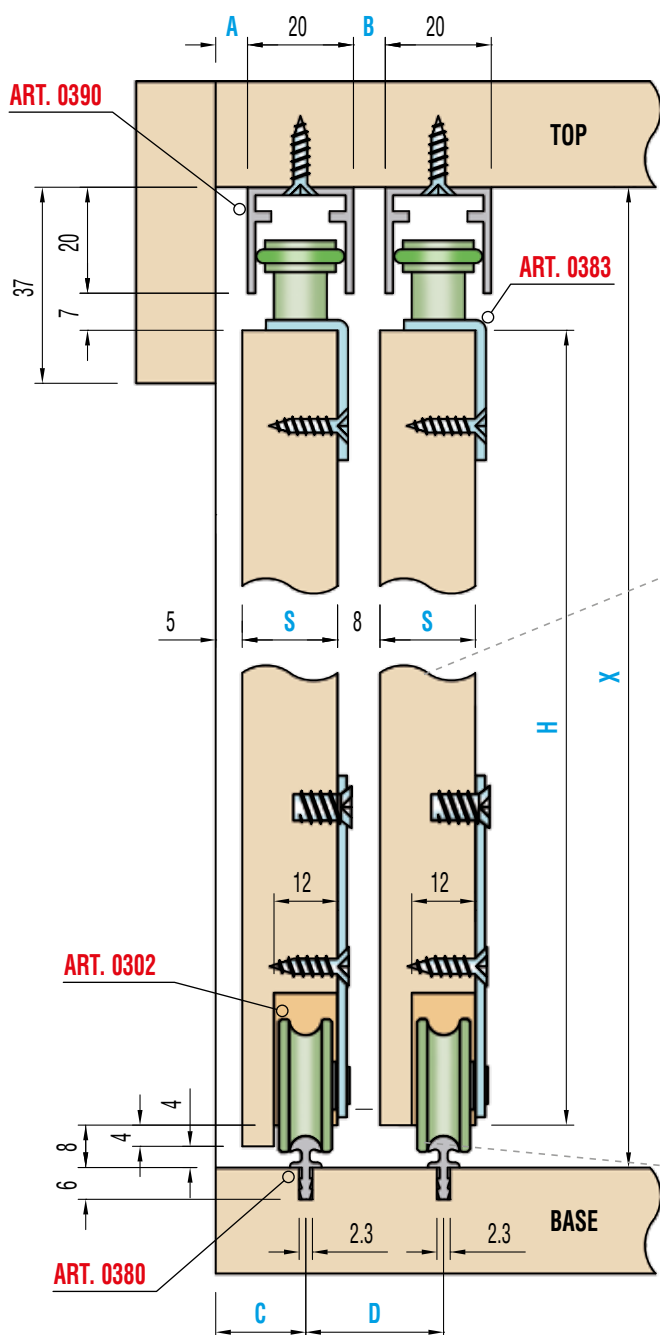

Peso massimo anta Kg. 50  
Maximum door weight Kg 50

A =	S* -12
B =	S* -12
C =	S* -1
D =	S* +8
H =	X -35

S\* (spessore / thickness)  
min.16

### Variante Special version

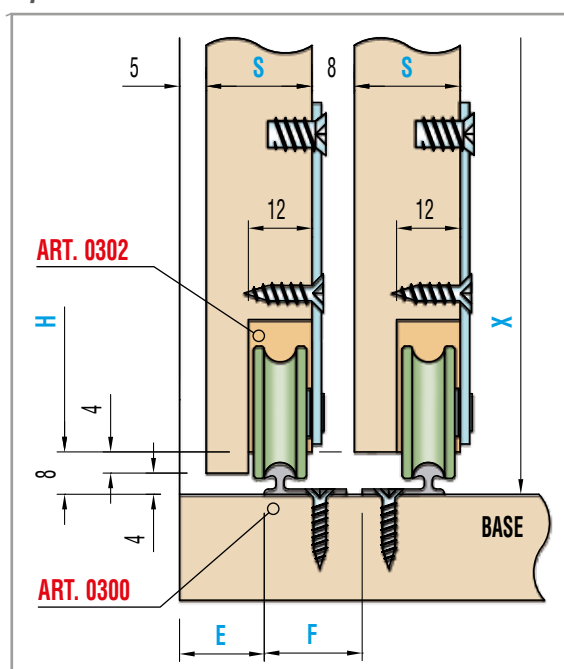

E =	S* -4
F =	S* -1,5
H =	X -35

### Schema Foratura ante / Doors drilling

